

Product information

Flow - magnetic inductive - probe form

**Flow Transmitter /
 Switch OMNI-FIS**



- Flow measurement in conductive fluids
- A measurement probe for a wide range of piping diameters
- High quality materials
- No moving parts
- Change the sensor without loss of media
- Analog output 4..20 mA or 0..10 V
- Two programmable switches
- Graphical LCD display, backlit, can be read in sunlight and in the dark
- Selectable units in the display
- Programmable parameters via rotatable, removable ring (programming protection)
- Electronics housing with non-scratch, chemically resistant glass
- Rotatable electronic housing for best reading position
- Designed for industrial use
- Small, compact construction
- Simple installation

Characteristics

The FIS magnetic-inductive flow probes are built into the piping by means of the supplied welded-on sleeves (DN 50..DN 400) or by means of the plastic fixing clip (DN 50..DN 150) .

The complete measurement probe is removable without creating an opening to the medium, and so if a fault occurs, only the electronic part is replaced.

When an electric conductor moves at right angles to the magnetic field, the movement induces a voltage U in the conductor. With this measurement principle, the electrically conductive medium is the conductor. The magnetic field B is transverse to the direction of flow. The induced voltage U is directly proportional to the local flow speed v.

The OMNI transducer located on the sensor has a backlit graphics LCD display which is very easy to read, both in the dark and in bright sunlight. The graphics display allows the presentation of measured values and parameters in a clearly understandable form. The measured values are displayed to 4 places, together with their physical unit, which may also be modified by the user. The electronics have an analog output (4..20 mA or 0..10 V) and two switching outputs, which can be used as limit switches for monitoring minimal or maximal, or as two-point controllers. The switching outputs are designed as push-pull drivers, and can therefore be used both as PNP and NPN outputs. Exceeding limit values is signalled by a red LED which is visible over a long distance, and by a cleartext in the display.

The stainless steel case has a hardened non-scratch mineral glass pane. It is operated by a programming ring fitted with a magnet, so there is no need to open the operating controls housing, and its

leakproofness is permanently ensured.

By turning the ring to right or left, it is simple to modify the parameters (e.g. switching point, hysteresis...). To protect from unintended programming, it can be removed, turned through 180 ° and replaced, or completely removed, thus acting as a key.



Technical data

Sensor	magnetic-inductive	
Nominal width	DN 50..300 welded-on nozzle DN 50..150 tapping sleeve	
Process connection	welded-on nozzle, tapping sleeve	
Metering ranges	full scales 1..8 m/s in steps of 1 m/s	
Measurement accuracy	±5 % of the measured value, (when calibrated on the spot ±2 % of the measured value), from 3 cm/s	
Repeatability	±2 % of the measured value	
Time constant	5 seconds fixed	
Media	conductive, largely homogeneous fluids, pastes, and slurries, also having solids components	
Electrical conductivity	min. 20 mS/cm	
Medium temperature	-25..+150 °C	
Ambient temperature	-25..+60 °C	
Pressure resistance	max. 25 bar, welded-on nozzle max. 10 bar, tapping sleeve	
Materials	Probe	stainless steel 1.4435
	Insulation	ceramic (zirconium oxide)
	Tapping sleeve	PP, 1.4305
	Electronics housing	stainless steel 1.4305 FKM and Klingerit
Materials non-medium-contact	Electronics housing	stainless steel 1.4305
	Glass	mineral glass hardened
	Magnet	samarium-Cobalt
	Ring	POM
Supply voltage	18..30 V DC	
Power consumption	< 2 W	
Analog output	4..20 mA / max. load 500 Ω or 0..10 V / min. load 1 kΩ	
Switching outputs	transistor output "push-pull" (resistant to short circuits and polarity reversal) I _{out} = 100 mA max.	
Hysteresis	adjustable, position of the hysteresis depends on minimum or maximum	

Product information

Flow - magnetic inductive - probe form

Display	backlit graphical LCD-Display (transreflective), extended temperature range -20..+70 °C, 32 x 16 pixels, background illumination, displays value and unit, flashing LED signal lamp with simultaneous message on the display.
Electrical connection	for round plug connector M12x1, 5-pole
Ingress protection	IP 67
Weight	see table "Dimensions"
Conformity	CE

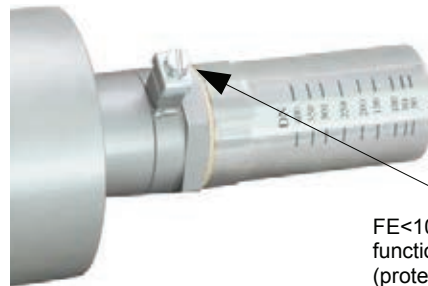

FE<10 Ohm
 functional earth
 (protective earth)
 (must be installed)

Signal output curves

Value x = Begin of the specified range
 ▴ = not specified range

Current output

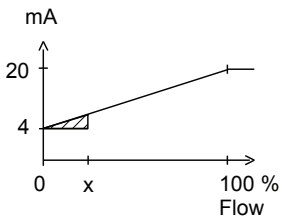

Voltage output

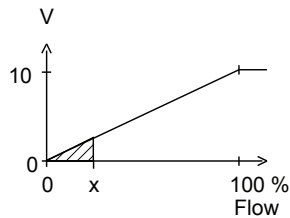

Other characters on request.



Wiring

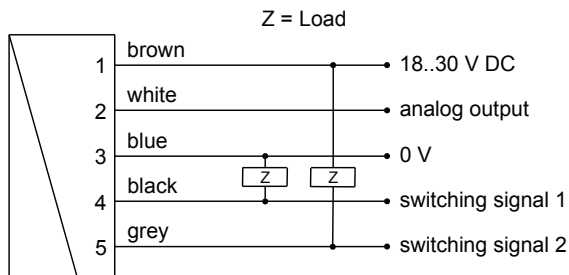

Connection example: PNP NPN

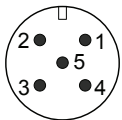

connector M12x1

Dimensions

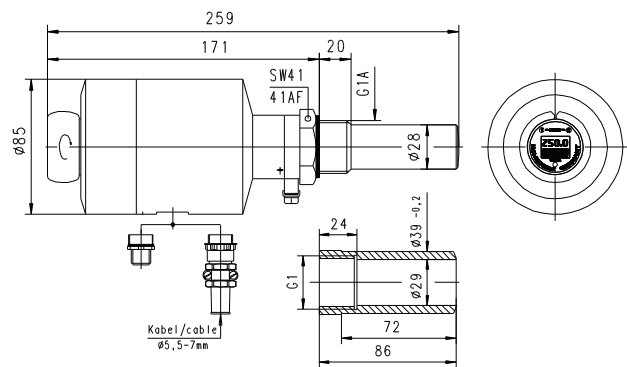

Product information

Flow - magnetic inductive - probe form

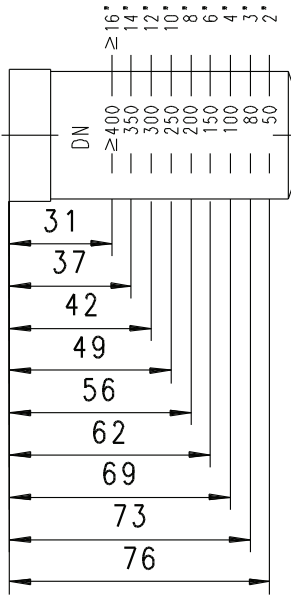

do with the alignment of the housing. This is possible at any time, without affecting the alignment of the internal component. The metering range full scale value has already been set in the factory to the desired metering range, by means of the DIP switches (1, 2, 3, 4, 5, 6, 7, 8 m/s, see drawing). The figures next to the DIP switches are valid.

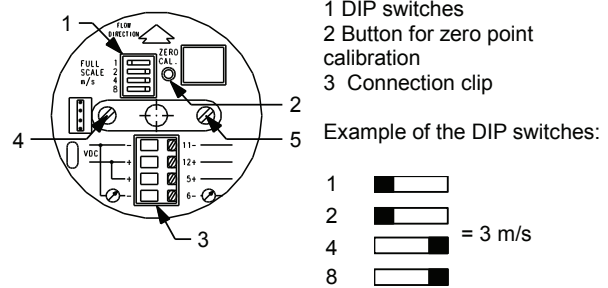

Zero point setting:

- Fill the piping completely with medium
- Flow speed in the piping must be "zero"
- Press the "ZERO CAL" button
- After one minute, the device has automatically self-calibrated

Programming

The annular gap of the programming ring can be turned to positions 1 and 2. The following actions are possible:



**Set to 1 = continue (STEP)
 Set to 2 = modify (PROG)**

**Neutral position between
 1 and 2**

The ring can be removed to act as a key, or turned through 180° and replaced to create a programming protector. Operation is by dialog with the display messages, which makes its use very simple. Starting from the normal display (present value and unit), if 1 (STEP) is repeatedly selected, then the display shows the following information in this order:

Display of the parameters, using position 1

- Switching value S1 (switching point 1 in the selected unit)
- Switching characteristic of S1
 MIN = Monitoring of minimum value
 MAX = Monitoring of maximum value
- Hysteresis 1 (hysteresis value of S1 in the set unit)
- Switching value S2
- Switching characteristic of S2
- Hysteresis 2
- Code
 After entering the **code 111**, further parameters can be defined:
- Filter (settling time of the display and output)
- Physical unit (Units)
- Output: 0..20 mA or 4..20 mA
- 0/4 mA (measured value corresponding to 0/4 mA)
- 20 mA (measured value corresponding to 20 mA)

For models with a voltage output, replace 20 mA accordingly with 10 V.

Edit, using position 2

Handling and operation

Installation

The FIS magnetic-inductive probes are installed in the pipework by means of the supplied welded-on sleeves or by means of the plastic fixing clip (≥ DN 50 / ≥ G 2). See diagrams for installation position and depth.

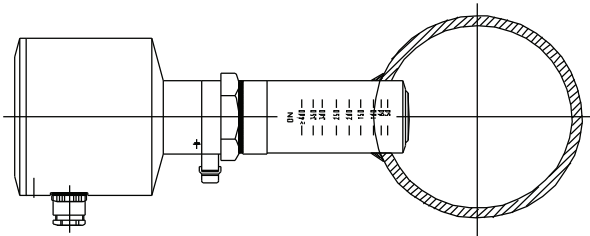

Weld on the nozzle at the marking according to its nominal width, free of distortion.

Run-in and run-out sections must be greater than or equal to 10 x pipework diameter. Weld on the connection sleeve at right angles to pipework mid-line (see marking = external pipework diameter, for >DN 400 also at 400). Avoid distortions. The probe must screw in easily. After screwing in, the probe can be adjusted by rotating it.

The complete measurement probe is removable without creating an opening to the medium, and so if a fault occurs, only the electronic part is replaced.

The electrical connection is made after opening the cover (unlosable because of its earthing cable). For this, completely remove the three internal hex bolts from the lid.

The arrow on the electronics insert must be in the direction of flow (loosen bolts 4 and 5 by approx. 2 or 3 turns. Do not remove completely) Turn the electronic component appropriately, and then tighten the bolts again. The alignment of the arrow has nothing to

